

# EFFER

RAISE THE VALUE



1855

ENGLISH / ITALIANO / DEUTSCH / FRANÇAIS / ESPAÑOL



1855

The crane 1855 is the ultimate expression of the cranes that can be installed on 32-ton trucks, also available in the version with articulation joint and winch. The model is also equipped with PROGRESS, the most comprehensive electronic management system of the crane.

La gru 1855 è la massima espressione delle gru installabili su autocarri da 32 tonnellate anche nella versione con snodo e verricello. Essendo dotata del PROGRESS, il più completo sistema elettronico di gestione della gru, permette di ottenere il pieno controllo della stabilità e della sicurezza gru.

Der kran 1855 auch in der Version mit Gelenk und Seilwinde das Maximum eines auf 32t-Lastwagen zu installierenden Krans. Das Modell ist außerdem mit PROGRESS ausgestattet, dem vollständigen elektronischen Steuerungssystem des Krans.

La grue 1855 est l'expression par excellence des grues pouvant être installées sur des camions de 32 tonnes, même dans la version avec articulation et treuil. Le modèle est en outre équipé du PROGRESS, le système électronique de gestion de la grue le plus complet.

La grúa 1855 es la máxima expresión de las grúas instalables sobre camiones de 32 toneladas aun en la versión con articulación y cabrestante. El modelo está dotado también con PROGRESS, el más completo sistema electrónico de gestión de la grúa.

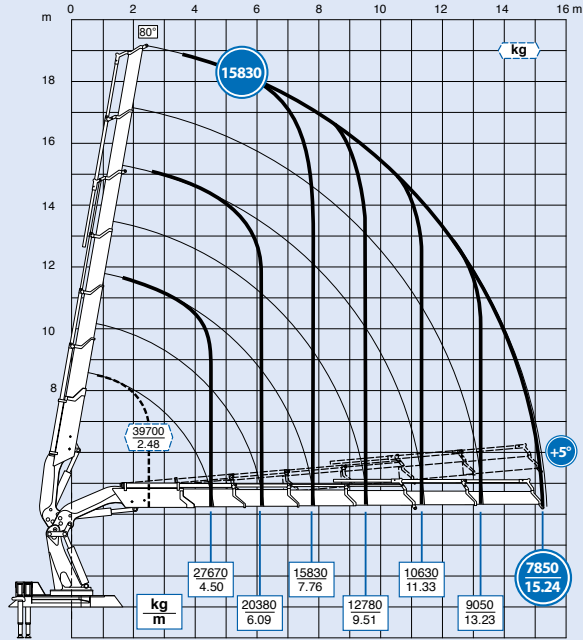
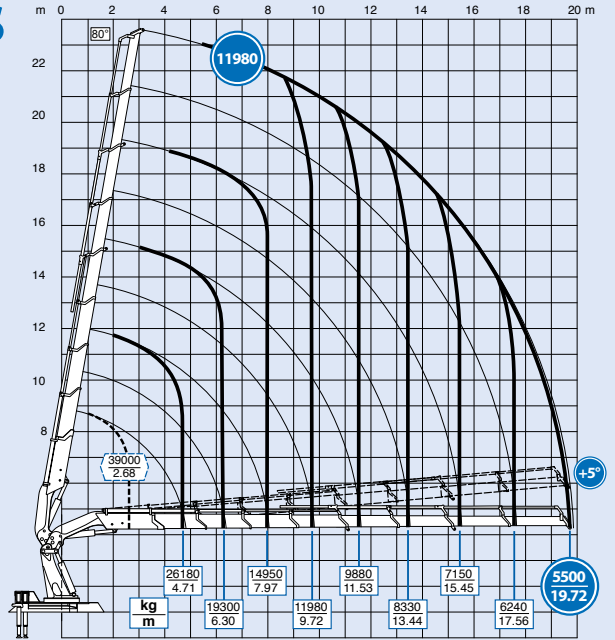
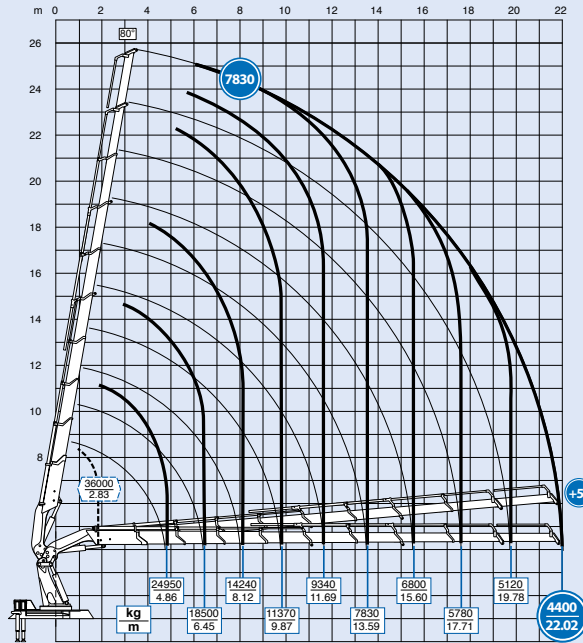
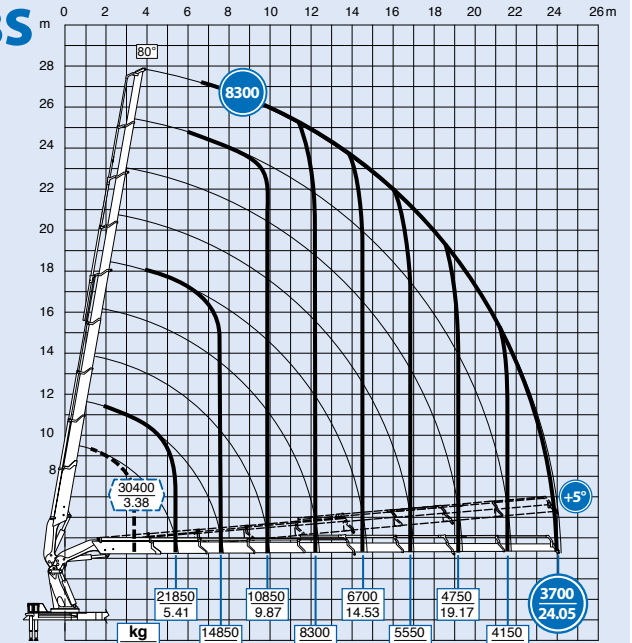
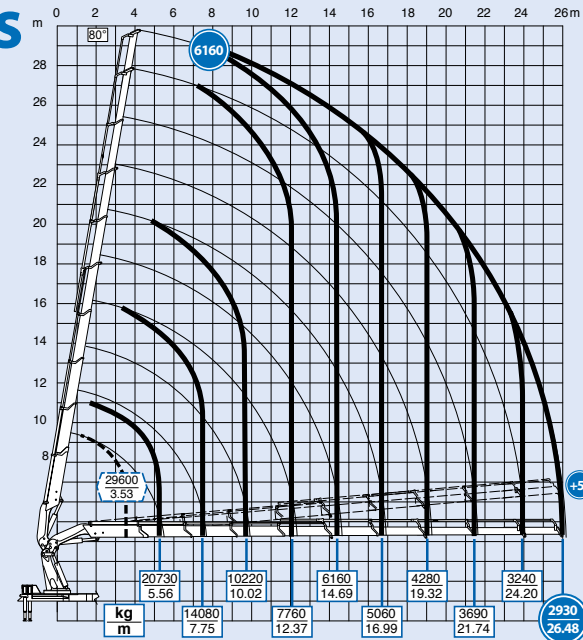
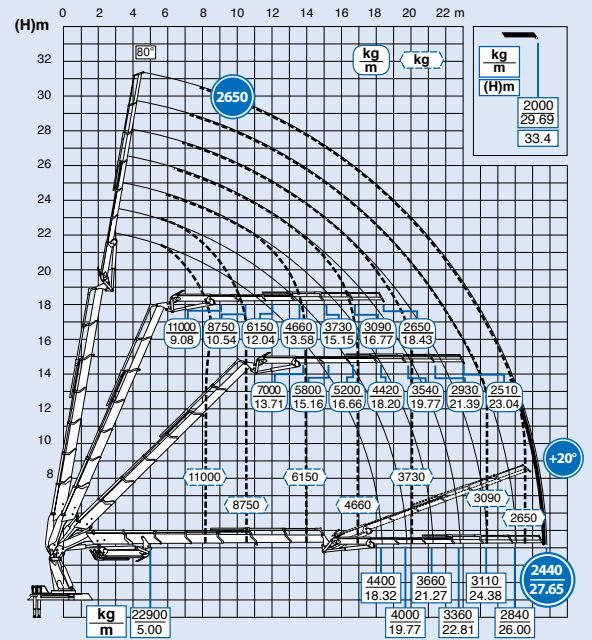

**6S****8S****9S****L8S****L9S****6S + JIB 6S Heavy Duty**

# 8S + JIB 6S Light

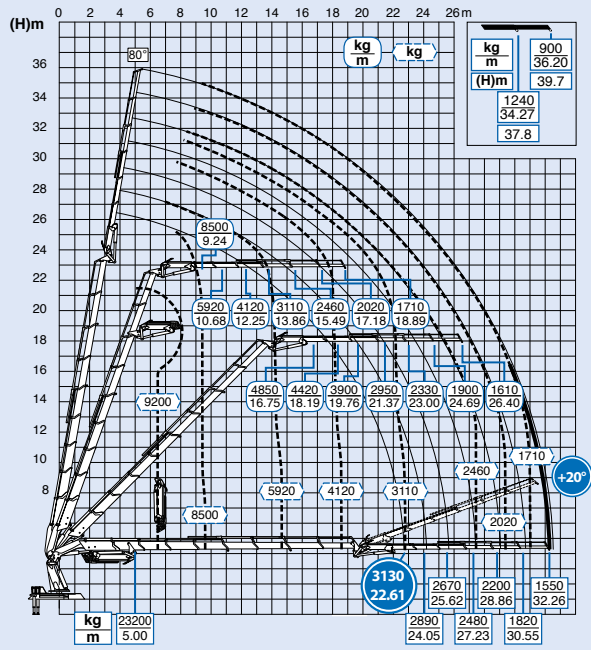

# 9S + JIB L6S

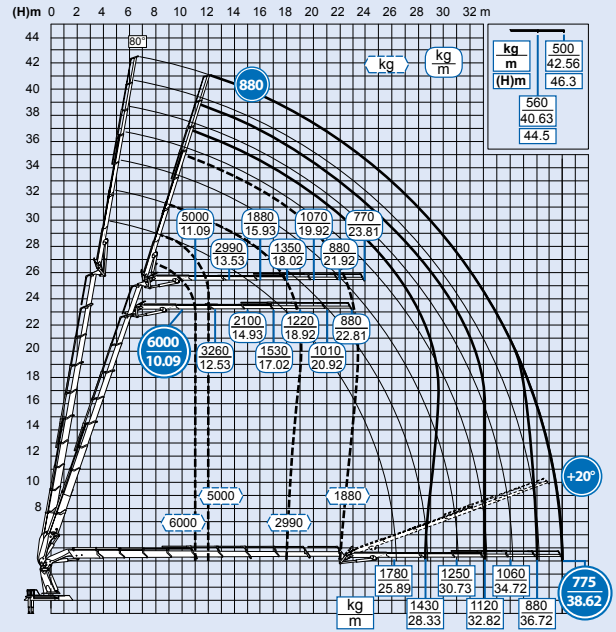

# L8S + JIB L6S

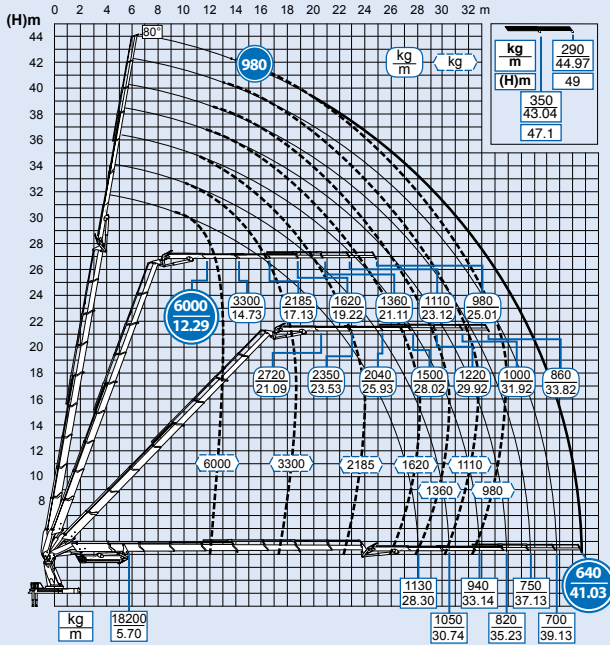

# L9S + JIB L6S

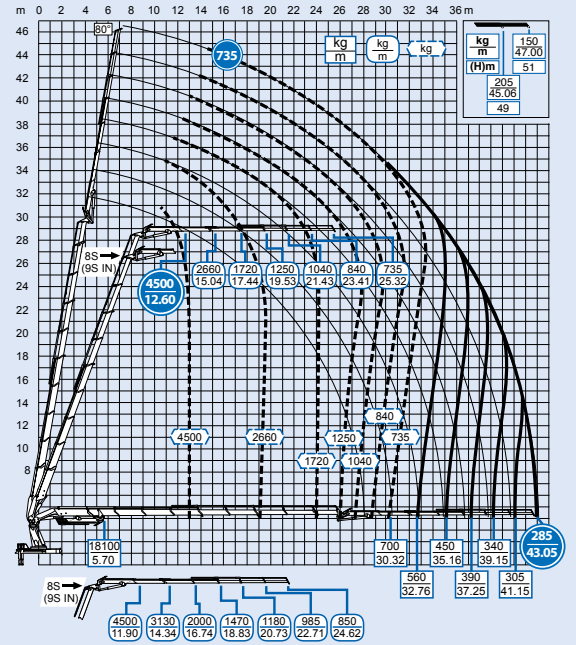

# 8S + JIB 6S

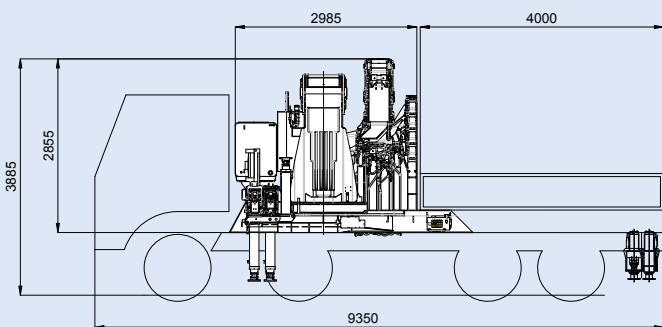

1855 8S	29000 kg*
1855 8S + JIB 6S	30500 kg*

\* Truck 10000 kg

[mm]

# L8S + JIB L6S

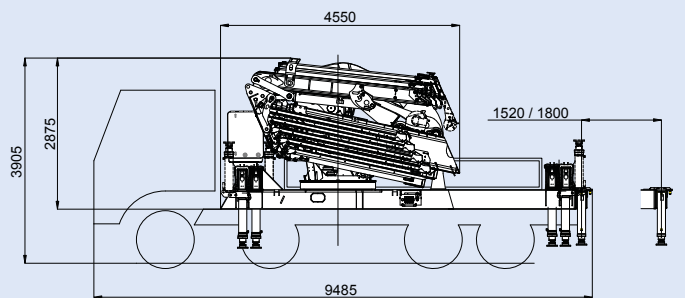

1855 L8S	30500 kg*
1855 L8S + JIB L6S	32000 kg*

\* Truck 10000 kg

[mm]

## STANDARD



## OPTIONAL



» FOR MORE INFO AND TECHNICAL DETAILS GO TO **EFFER PRODUCT GUIDE**

DESCRIPTION	UNIT OF MEASURE	4S	6S	8S	9S	L8S	L9S
Max. hydraulic outreach Massimo sbraccio idraulico orizzontale Max. hydraulische Reichweite waagerecht Portée hydraulique horizontale maxi. Máximo alcance hidráulico horizontal	m	11,31	15,40	19,88	22,18	24,21	26,64
Max. lifting moment (+20°) Momento massimo di sollevamento (+20°) Max. Hubmoment (+20°) Moment de levage maxi. (+20°) Momento máximo de elevación (+20°)	kgm	129230	124660	123310	121360	117150	115260
	kNm	1270	1220	1210	1190	1150	1130
Slewing arc Angolo di rotazione Schwenkbereich Angle de rotation Angulo de giro	[°]	endless / continua / endlos / sans fin / sin fin					
Slewing Capacity - Max slope Capacità di rotazione - Massima pendenza Rotationskapazität - Maximale Neigung Capacité de rotation - Pente Maxi Capacidad de rotación - Máxima inclinación	%	8,7					
Working pressure Pressione d'esercizio Betriebsdruck Pression de travail Presión de trabajo	bar	375 (L:365)					
Recommended oil delivery Portata d'olio consigliata Empfohlene Ölfördermenge Débit d'huile recommandé Caudal de aceite aconsejado	l/min	200					
Oil tank capacity Capacità serbatoio olio Öltankkapazität Capacité du réservoir d'huile Capacidad tanque de aceite	l	500					
Weight of the standard crane (± 2%) Peso gru standard (± 2%) Gewicht des Standardkranes (± 2%) Poids propre de la grue standard (± 2%) Peso grúa estandar (± 2%)	kg	12120	13070	13870	14340	14370	14870



#### **CRANE DESIGNED ACCORDING TO STANDARDS UNI EN 12999 HC1 S1 HD5**

The configurations and figures contained in the brochure are illustrative. For information on the complete offer and for more technical details, ask your Effer dealer or consult the website [www.effer.com](http://www.effer.com). The above data are subject to change. Lifting capacity is based on the maximum lifting power of the crane. The stability of the truck may require a reduction of lifting capacity.

#### **GRU PROGETTATA SECONDO NORME UNI EN 12999 HC1 S1 HD5**

Le configurazioni e le immagini riportati nel depliant sono esemplificativi. Per conoscere l'offerta completa e per maggiori dettagli tecnici, rivolgersi al concessionario EFFER di zona e consultare il sito [www.effer.com](http://www.effer.com). I dati indicati possono subire modifiche. Capacità di sollevamento secondo potenza massima della gru. La stabilità dell'autocarro può richiedere il declassamento.

#### **KRAN ENTWICKELT GEMÄSS UNI EN 12999 S1 HC1 S1 HD5**

Die in der Broschüre enthaltenen Ausstattungen und Bilder dienen als Beispiel. Um das komplette Angebot zu kennen und für weitere technischen Informationen, wenden Sie sich an Ihren Händler EFFER und besuchen Sie unsere Homepage [www.effer.com](http://www.effer.com). Die geschriebenen Angaben können Änderungen vorsehen. Tragkraft gemäss maximale Kranleistung. Die Stabilität des Lastwagens kann die Deklassierung erfordern.

#### **GRUE PROJETEE SELON LES NORMES UNI EN 12999 HC1 S1 HD5**

Les configurations et les images contenues dans les dépliants sont exemplificatives. Pour connaître l'offre complète et les détails techniques, veuillez contacter votre revendeur EFFER et consulter le site [www.effer.com](http://www.effer.com). Les données indiquées peuvent subir des modifications. Capacité de levage selon la puissance maximum de la grue. La stabilité du véhicule peut nécessiter le déclassement.

#### **GRÚA DISEÑADA SEGÚN LAS NORMAS UNI EN 12999 HC1 S1 HD5**

Las configuraciones y las imágenes incluidas en el folleto se proporcionan a modo de ejemplo. Para conocer la oferta completa y para más detalles técnicos, consultar con el concesionario EFFER local y visitar el sitio web [www.effer.com](http://www.effer.com). Los datos indicados pueden sufrir modificaciones. Capacidad de elevación según la potencia máxima de la grúa. La estabilidad del camión puede requerir el desclasamiento.



### **EFFER S.p.A.**

Via IV Novembre, 12 | 40061 Minerbio (BO) – Italy  
Tel. +39 051 4181211 | Fax. +39 051 4181491  
S.P. 40 ex Vicinale Accetta Grande | 74010 Statte (TA) – Italy  
Tel +39 099 4700191 | Fax +39 09 9 4700189  
[www.effer.com](http://www.effer.com) | [info@effer.it](mailto:info@effer.it)

